

User Manual



ZLight

ZigBee® device
for electric light bulbs

Revision: 2.0

date : 10/08/2015

Status : Approved

Reference : UM_ZLight_20110922_001_02_00

Warranty

The device supplied to the buyer and/or the recipient is guaranteed by **CLEODE** against any malfunctions originating from a design and/or manufacturing flaw, for a period of twelve (12) months following delivery. The buyer and/or recipient is (are) responsible for proving the existence of the said defects or flaws. This warranty is applicable in accordance with articles 1641 to 1648 of the French Civil Code and in compliance with the French statutory warranty. The warranty covers the replacement free of charge of devices and parts affected by a design and/or manufacturing flaw excluding conspicuous defects in the device that are covered by the buyer and/or the recipient.

In order to invoke the warranty, the buyer must immediately send written notice to **CLEODE** of the flaws that it attributes to the device. It must enable **CLEODE** to have access to the device to observe these defects and repair them. The warranty provided by **CLEODE** is strictly limited to the equipment provided and shall only have for effect the replacement or repair, at **CLEODE's** expense, on its own premises, of all devices or parts that are not functioning as a result of defects or flaws. **CLEODE** reserves the right to modify the devices in order to comply with the warranty.

The warranty does not apply to replacement or repairs that may result from normal wear and tear of devices, systems or products, damage or accidents resulting from negligence, failure to supervise or maintain, or incorrect use of the devices, systems and/or products.

The maintenance service is provided by **CLEODE** with all reasonable care possible and in compliance with the current state of the arts.

The exchange of parts or repairs performed under the warranty cannot result in extending the length of the warranty. In no event can the unavailability of the device due to servicing give rise to compensation for any reason whatsoever. The seller is released from all obligations relating to the warranty if the product or device has been modified without prior written consent, or if original parts have been replaced by parts which it has not manufactured without prior consent. If unforeseen damage is caused by the device, it is expressly agreed that the seller can only be liable for the reimbursement of monies received for the purchase of the device if it has been destroyed. Under no circumstances can the seller be held liable for indirect or contingent damage. The seller is released from any liability and the buyer waives any rights against it if an accident or direct or indirect damage is caused to the buyer following a defect, incorrect usage, incorrect maintenance or normal wear of the device sold.

Table of revision

Version	Author(s)	Version description	Date
0.1	CLEODE	Initial version	09/15/2011
1.0	CLEODE	Document validation	09/21/2011
1.1	CLEODE	Update for new hardware version	10/05/2015
2.0	CLEODE	Document validation	10/08/2015

Reference documents

N°	Document	Description
[1]	ZigBee_Cluster_Library_Public	Specification of the ZigBee® Cluster Library
[2]	ZigBee_Home_Automation	Specification of the Home Automation profile
[3]	ZigBee_Specification	Specification of the ZigBee® standard

Table of contents

I. OVERVIEW ET TECHNICAL CHARACTERISTICS	7
I.1 OVERVIEW	7
I.2 RED LIGHT MEANINGS	7
I.3 TECHNICAL CHARACTERISTICS	8
II. 'QUICK START'	9
III. PROCEDURES	10
III.1 INSTALLATION	10
III.1.1 POWER WIRING	10
III.1.2 WIRING OF ELECTRIC LIGHT BULBS	10
III.1.3 WIRING OF SWITCHES	11
III.2 PAIRING OF THE PRODUCT FOR THE FIRST TIME	12
III.3 RESET OF THE PRODUCT	12
IV. SOFTWARE INTERFACE	13
IV.1 OVERVIEW	13
IV.2 APPLICATION	13
IV.2.1 DESCRIPTION OF THE APPLICATION	13
IV.2.2 DESCRIPTION OF CLUSTERS	13
IV.2.2.1 Cluster Basic	13
IV.2.2.2 Cluster Identify	14
IV.2.2.3 Cluster Group	14
IV.2.2.4 Cluster Scenes	14
IV.2.2.5 Cluster On/Off	14
V. TECHNICAL ISSUES	15

Table of figures

FIGURE 1 : GLOBAL VIEW OF THE ZSHADE DEVICE	7
FIGURE 2 : POWER WIRING	10
FIGURE 3 : WIRING OF ELECTRICAL BULBS	11
FIGURE 4 : WIRING OF A SWITCH FOR ROLLER SHUTTER	11

I. Overview et technical characteristics

I.1 Overview

The ZLight product is a ZigBee® device for electric light bulb management. It can be managed in different ways:

- On reception of ZigBee® command (on the On/Off Light cluster)
- Or by switches.

The device is presented as follow:

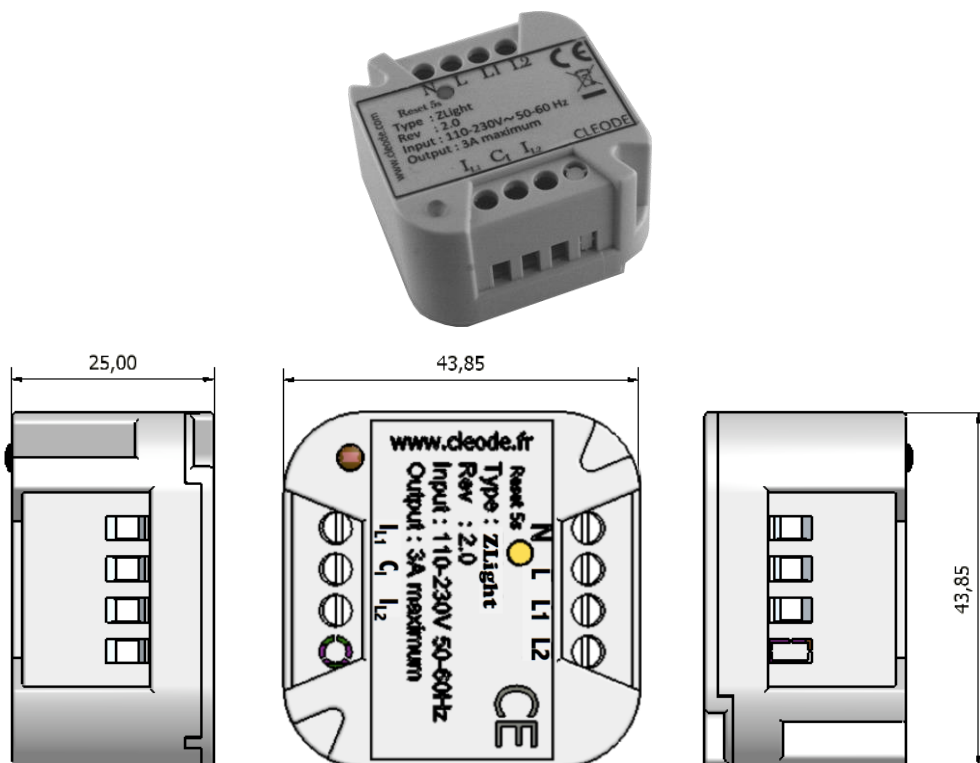

Figure 1 : Global view of the ZShade device

I.2 Red light meanings

The red indicator shows the state of the device.

This indicator takes the following states depending on the modes described in the table below:

Legends :



Off



Slow flash





On with steady light for 2s



Rapid flash

Mode	Etat		Description
Default			Without special announcement, the association led remains off.
On starting		2 fois	To start the device announces its State by 2 slow flashes

Identification		The given time in the frame Identify	During the identification period, the device is identified via slow flashes as long as the duration of identification is not exceeded.
Manual starting of pairing process		20 seconds max	The device reports by quick flashes that it is in coordinator research stage.
Pairing OK		2 seconds	Once paired, the device announces its state with steady light for 2s.

I.3 Technical characteristics

Stack ZigBee®	ZigBee® Pro 2007 16 channels
Radio range	About 150 m (indoor)
Operating temperature	+5 à +45 °C
Electrical supply	110-230V / 50-60Hz
Maximum current capability	3A
Measurement	44 x 44 x 25 mm
Number of managed light bulbs	2

II. 'Quick Start'

Rapid implementation procedure:

- 1) Install the **ZLight** product (For more details, refer to chapter III.1).
- 2) Pair the **ZLight** product in the ZigBee® network (For more details, refer to chapter III.2).
- 3) The product is operational in your ZigBee® network.
- 4) Test the operation of the **ZLight** product.

III. Procedures

III.1 Installation



IMPORTANT: This product permits a maximum current of 3A, it should not be used to power light bulbs greater than 3A.

III.1.1 Power wiring

The ZLight must be supplied with a mains voltage between 110V and 230V with a frequency between 50 Hz and 60 Hz. The wiring must be carried out as shown in the image below:

- The neutral is represented by letter N (blue wire)
- The phase is represented by letter L (red wire)

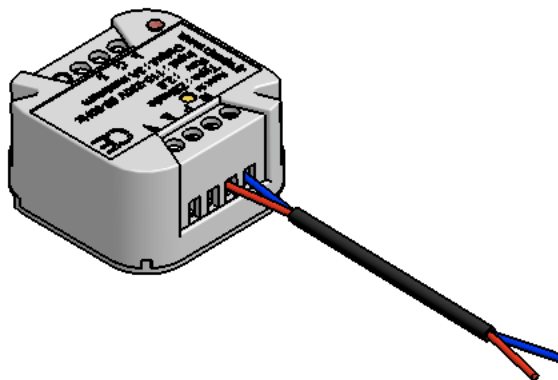

Figure 2 : Power wiring

III.1.2 Wiring of electric light bulbs

Light bulbs must accept the same voltage as the power supply of the ZLight (110-230V/50-60Hz).

Light bulbs must be wired as below:

- The neutral is represented by the letter N (blue wire), it must be connected with the neutral of the power supply
- The main phase is represented by the letter L (red wire), it must be connected with the main phase of the power supply
- The first switched phase used for the light bulb #1 management is represented by L1 (black wire)
- The second switched phase used for the light bulb #2 management is represented by L2 (brown wire)



The color of wires is given as an example, may be that they do not correspond with the cable used.

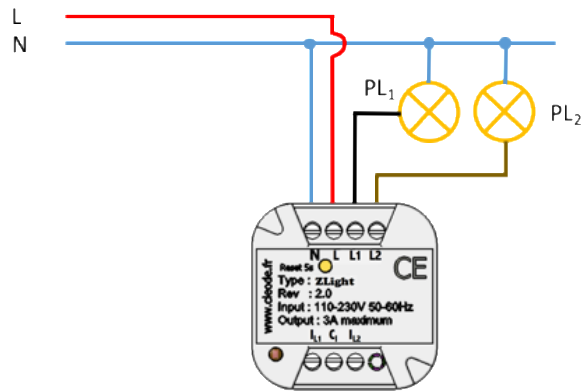

Figure 3 : wiring of electrical bulbs

III.1.3 Wiring of switches

It is possible to manage the ZLight product by a wired switch for electric bulbs

To use a switch, you must connect it as shown below:

- C_1 : connect this output to the common inputs of all switches (red wire)
- I_{L1} : connect this input to the first switch (purple wire)
- I_{L2} : connect this input to the second switch (orange wire)



The color of the wires is given as an example.

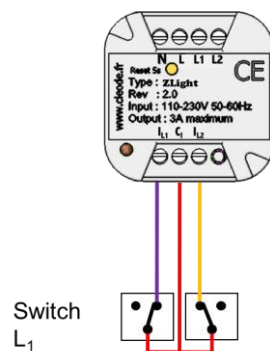

Figure 4 : wiring of a switch for roller shutter



Do not use an external power supply on the switch, at the risk of damaging the product ZLight.

The ZLight product provides itself, the voltage to operate the switch.

III.2 Pairing of the product for the first time

To integrate the ZLight product into a ZigBee® network, proceed with pairing as follows:

- 1) Allow the addition of a ZigBee® device in your network (see the user manual of your coordinator).
- 2) At power-up, the ZLight product tries to associate and blinks twice.

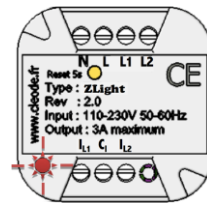

- 1) If a coordinator is present and allows the ZLight to join, the ZLight indicator will light for 2 seconds then turns off.

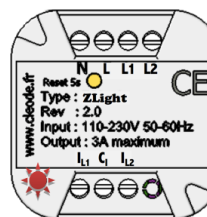

III.3 Reset of the product

To clear the ZLight network settings, proceed as follows:

- 1) Press the pairing button 5 seconds.

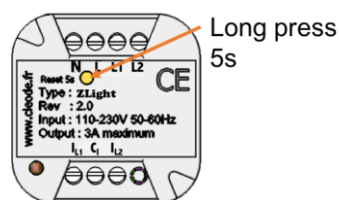

- 2) When the ZLight is reset, the indicator flashes 2 times and shuts off.

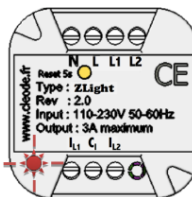

IV. Software interface

IV.1 Overview

The ZLight contains a On/Off Light application defined in the Home Automation standard (See document [2]).

This device conforms to the standard ZigBee[®] PRO 2007 and the Home Automation 1.2 profile. For more details on the data exchanged, please refer to the documents [1], [2] and [3].

IV.2 Application

IV.2.1 Description of the application

- Device ID : On/Off Light
- EndPoint numbers : 1, 2
- Clusters:

Server	Client
Basic (0x0000)	/
Identify (0x0003)	/
Groups (0x0004)	/
Scenes (0x0005)	/
On/Off (0x0006)	/

IV.2.2 Description of clusters

Here is a brief description of the clusters and the attributes implemented in the ZLight product. For more precision on the functioning thereof, please refer to the document [1].

IV.2.2.1 Cluster Basic

This cluster hosts the version information, name of manufacturer, model of the object, etc.

Attribut	Attribut ID
ZCLVersion	0x0000
ApplicationVersion	0x0001
StackVersion	0x0002
HWVersion	0x0003
ManufacturerName	0x0004
ModelIdentifier	0x0005
DateCode	0x0006
PowerSource	0x0007
LocationDescription	0x0010
PhysicalEnvironment	0x0011

DeviceEnabled	0x0012
AlarmMask	0x0013

IV.2.2.2 Cluster Identify

This cluster is used to physically identify the object in the network. On writing the value of the *IdentifyTime* attribute, the object light will blink during the time specified by this value.

Attribut	Attribut ID
IdentifyTime	0x0000

IV.2.2.3 Cluster Group

This cluster is used to manage scenes incorporating the ZLight product.

Attribut	Attribut ID
NameSupport	0x0000

IV.2.2.4 Cluster Scenes

This cluster is used to memorize the names of the groups to which the ZLight product belongs.

Attribut	Attribut ID
SceneCount	0x0000
CurrentScene	0x0001
CurrentGroup	0x0002
SceneValid	0x0003
NameSupport	0x0004

IV.2.2.5 Cluster On/Off

This cluster is used to manage electric bulb switching.

Attribut	Attribut ID
On/Off	0x0000

V. Technical Issues

Description of the problem	Verifications to be done
The electric bulb lights up when I want to turn off.	The wiring of the switch has been reversed. Redo the wiring correctly
I can't associate the ZLight product in my ZigBee® network.	Verify that your coordinator accepts the associations and the ZLight is located in radio range of the other ZigBee® network elements (Coordinator, routers).
The ZLight device no longer meets ZigBee® commands or commands to the switch.	Check that the ZLight is always powered.

Repair and maintenance

Defective hardware will be returned to the premises of CLEODE accompanied by:

- A copy of the delivery,
- A detailed description of its appearance dysfunction observed.

The average maintenance time is four (4) weeks from the back to the factory.

The information provided on the label are as follows:

- Model,
- Year of production,
- Reference and Version,
- Serial Number.

This information may you be requested by the company CLEODE to identify your hardware.

Requests for support should be addressed to:



CLEODE S.A.S
Service Support et Maintenance

3 rue Thomas Edison
22300 LANNION
Tel : +33 (0) 2 96 48 68 18
Fax : +33 (0) 2 96 48 19 11

E-mail : support@cleode.com
Web : <http://www.cleode.com>

End of User manual